

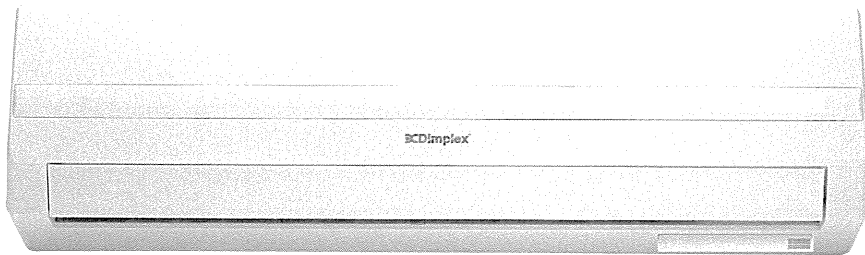

SPLIT SYSTEM AIR CONDITIONER

OWNER'S MANUAL & INSTALLATION MANUAL

MODEL: GD24I



Thank you for Choosing a Dimplex Air Conditioner, Please read this OWNERS MANUAL carefully prior to use.

◆ CONTENTS

Operation and maintenance

☒ Instructions prior to operation	2
☒ How to use your air conditioner	3
☒ Names and functions of each part	5
☒ Operation of remote control	6
☒ Emergency operation	11
☒ Clean and care	12
☒ Troubleshooting	14

Installation service

☒ Installation instructions	17
☒ Installation dimension diagram	19
☒ Installing indoor unit	20
☒ Installing outdoor unit	22
☒ Post-Installation check list and operation test	24
☒ Installation and Maintenance of Silver Ion Filter	25



Do not carry out any operation marked by this symbol.



Always follow instructions for items marked with this symbol.

Thank you for choosing a DIMPLEX air conditioner, please read this owner's manual carefully before operating the unit and keep it for future reference.

The product images in this manual may be slightly different to your actual unit. Depending on the model, some models have a display and some models don't, for actual position and shape of the displayer/finish please refer to the physical unit itself.













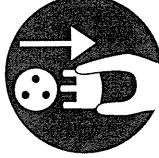

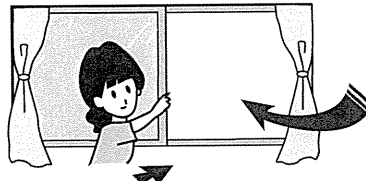
This appliance is not intended for use by persons (including children) with reduced physical, sensory or mental capabilities or lack of experience and knowledge, unless they have been given supervision or instructions concerning use of the appliance by a person responsible for their safety.

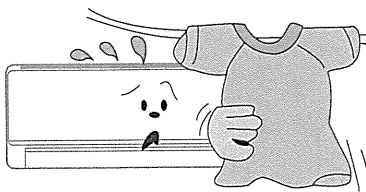
Children should be supervised around this appliance at all times.

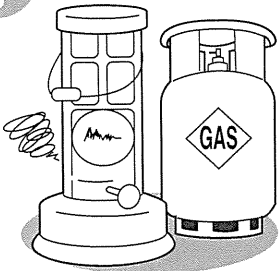

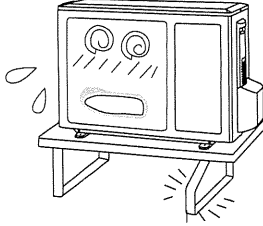
Do not dispose this product as unsorted municipal waste. Collection of such inorganic waste requires special collection by local authorities.

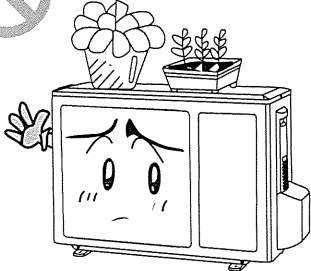
◆ Operation and maintenance

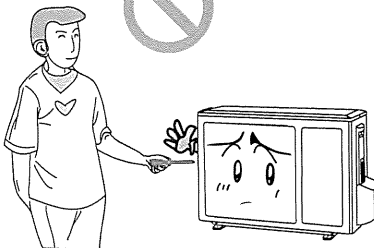
<p>⊠ This Dimplex Air conditioner must be installed by a qualified installer.</p>   <p>The appliance also needs to be wired by a qualified electrician.</p> <p>Failure to follow any terms depicted in this manual will void the warranty.</p>	<p>⊠ Unplug the air conditioner when not used for a long period.</p>  	<p>⊠ Select the most appropriate temperature.</p> <p>We recommend setting the temperature at 18 - 20 °C</p>  <p>This will save power usage</p>
<p>⊠ Do not leave windows and doors open for extended periods whilst running the air conditioner.</p>  <p>It will decrease the effectiveness of your air conditioner.</p>	<p>⊠ Do not block the air intake or outlet vents on either the outdoor or indoor units.</p>   <p>This may cause a malfunction or decrease the effectiveness of your air conditioner.</p>	<p>⊠ Keep flammable or combustible materials further than 1 m from this unit.</p>  
<p>⊠ Please make sure the stand under this unit is secure and solid.</p>   <p>If it is damaged or unstable, the unit may fall and cause injury. It may also not function correctly and it can void your Dimplex warranty.</p>	<p>⊠ Do not use the air conditioner as a step, or keep anything on top of the unit.</p>   <p>This can lead to injury to you and damage to the unit.</p>	<p>⊠ Do not disassemble, repair, or modify the unit.</p>   <p>Please contact a qualified technician for assistance with repairs.</p>

◆ Instructions prior to operation

- ☒ If the power cord is damaged, it must be replaced by the manufacturer or a service agent or a similarly qualified person in order to avoid a hazard.



- ☒ The airflow direction is adjustable. The vertical direction of the airflow can be adjusted with the upward/downward louvers. The horizontal direction of airflow can be adjusted with the left / right louvers.

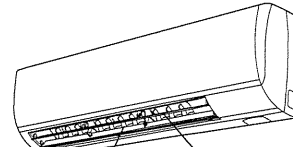

Horizontal louvre Vertical louvre

- ☒ Do not insert your hands into any part of the unit, including the intake/outlet vents, whilst unit is in operation

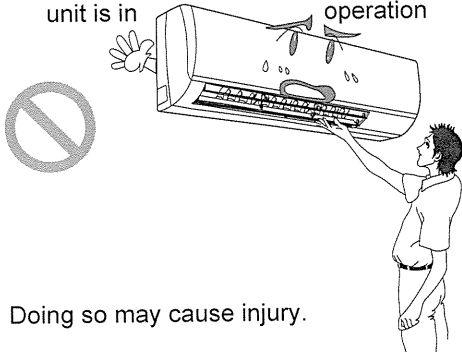

Doing so may cause injury.

- ☒ Do not place plants or pets where they may be exposed to direct airflow from the air conditioner.

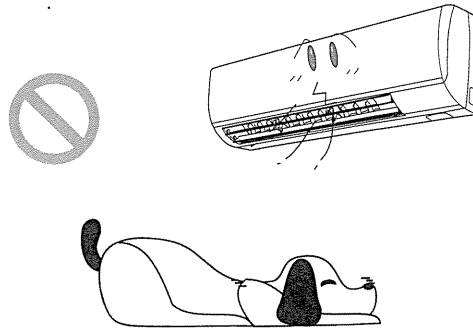

- ☒ Do not direct airflow onto persons for extended periods of time.

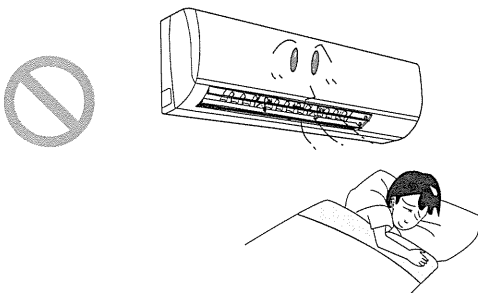

- ☒ Do not use the air conditioner for other purposes, such as drying clothes, preserving foods, etc.

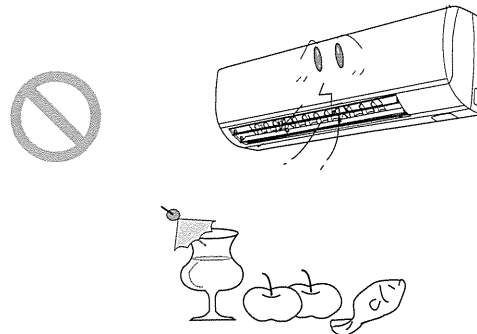

- ☒ Splashing water on the air conditioner can cause an electric shock or malfunction.

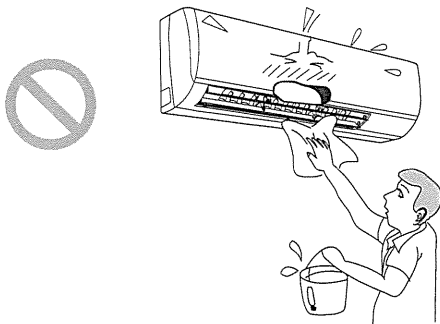

- ☒ Do not place the unit near an oven or cooktop.

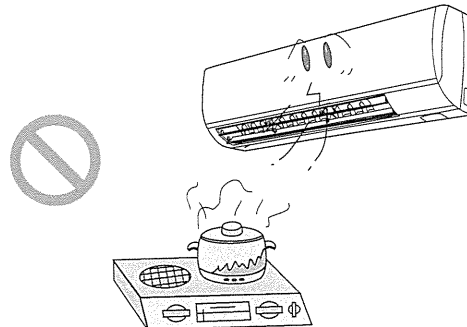

◆ How to use your Dimplex Air Conditioner

Working mechanism and special functions for cooling mode

Principle:

Air conditioners absorb the heat in a room, then transmit that heat outdoors, where it is then discharged. This decreases the ambient indoor temperature. The cooling capacity of the air conditioner may increase or decrease depending on the outdoor ambient temperature.

Anti-freezing function:

If the unit is running in COOL mode and the outdoor ambient temperature is low, frost may form on the heat exchanger. If the indoor heat exchanger temperature drops below 0 degrees Celsius, the unit's indoor microcomputer will stop the compressor in order to protect the unit.

Working mechanism and special functions for heating mode

Principle:

- * This unit also functions as a heater. It absorbs heat from outdoors and transmits it indoors, thereby raising the indoor ambient temperature. The effectiveness of this function may decrease if the outdoor ambient temperature decreases.
- * If the ambient outdoor temperature becomes too cold, please use other heating methods. The unit will continue to function down to -10°C, however defrost settings will activate it self more often during these lower temperatures.

Defrosting:

- * If the ambient temperature outside is low but the humidity is high, frost may form on the outdoor unit and affect the heating capabilities. If this occurs, the auto-defrost function will activate and the fan motors on both the indoor and outdoor units will halt, disrupting the heat output for 8-10 minutes.
- * During the auto-defrost sequence, vapour may be emitted from the outdoor unit. This is normal and not a malfunction.
- * When the auto-defrost sequence is complete, heating will resume automatically.

The climate type of this unit is according to the nameplate.

The external static pressures at which the appliance was tested should be zero Pa.

◆ How to use your Dimplex Air Conditioner

Anti-cool air function:

The unit is designed not to blow cold air on HEAT mode when the indoor heat exchanger is in one of the following three situations:

1. When heating mode begins
2. After the auto-defrost function has just finished.
3. Heating in very low temperatures.

Gentle Breeze

The unit may automatically rotate to a certain position and blow a gentle breeze in the following situations:

1. When the unit is turned on, in HEAT mode, and the compressor hasn't reached the starting position.
2. When the unit is in HEAT mode, the temperature has arrived at the prescribed value, and the compressor has stopped running for approximately 1 minute.

The operating temperature range (outdoor temperature) for cooling only models: 21° ~ 43°C
for cooling and heating units: -10° ~ 45°C

◆ Names and functions of each part

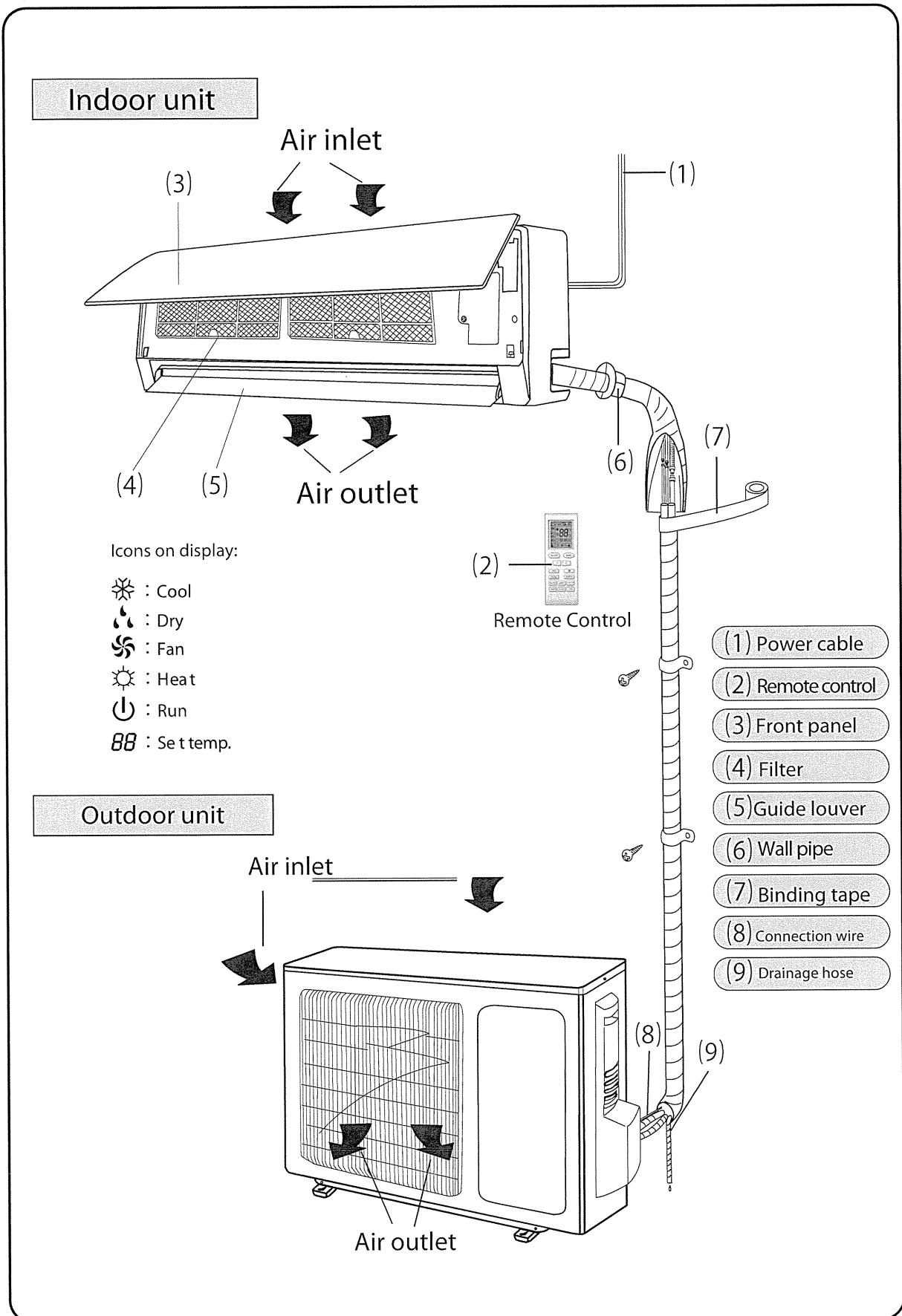

Remote control operation procedure

● Description and Functions of Remote control

Note:

- Be sure that there is no obstruction.
- Do not drop or throw the remote control.
- Do not place the remote control in a location where it may be exposed to direct sunlight.
- The unit will automatically resume to its most recent settings from its initial operation and the outdoor unit will start after a short delay.

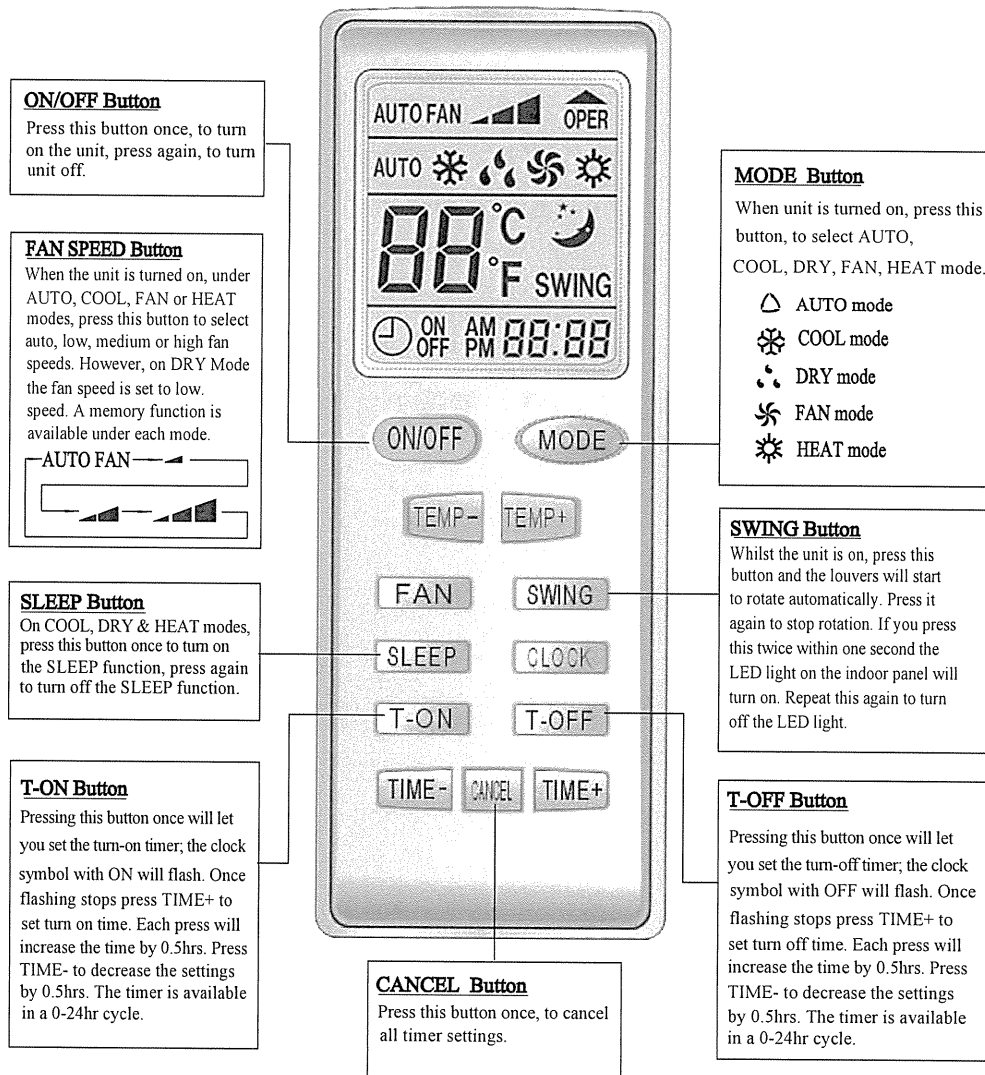

● Description and Functions of Remote Control (continued)

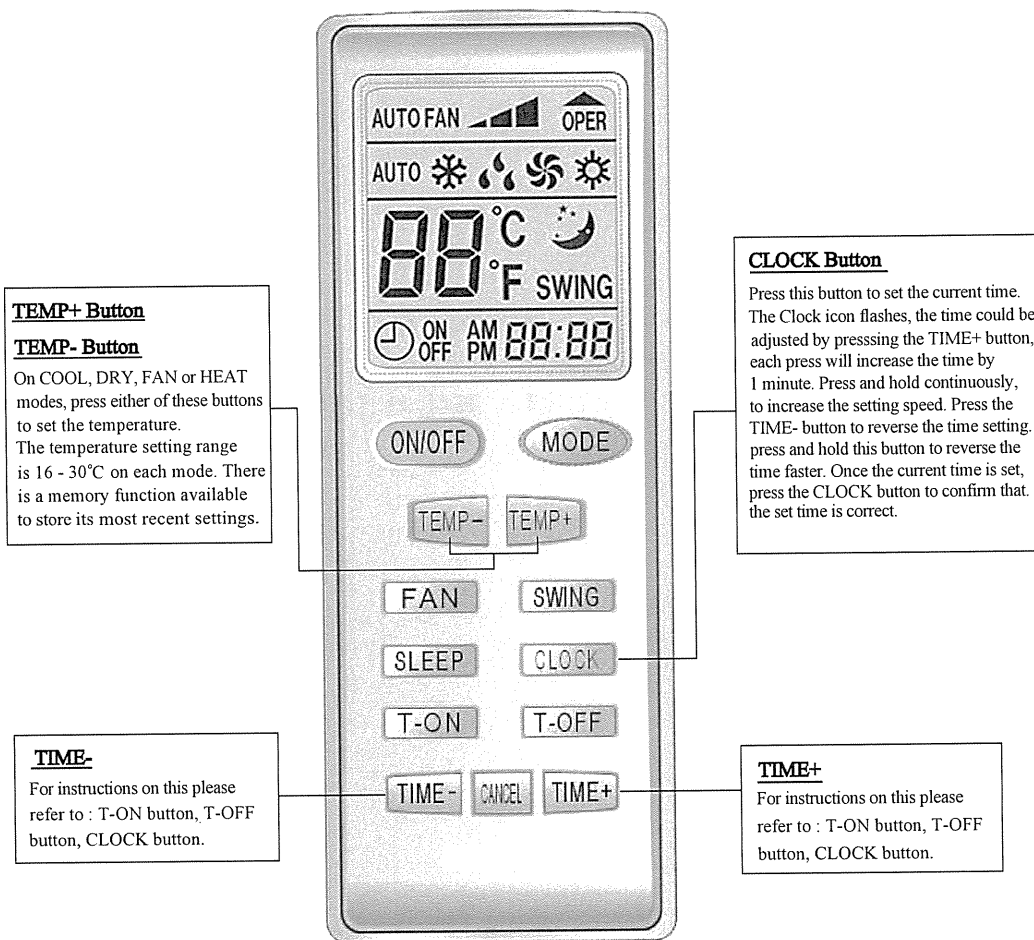

● How to insert batteries

- 1.Remove the cover from the back of the remote control.
- 2.Insert the two batteries(AAA dry-cell batteries), making sure to match the polarity.
- 3.Re-attach the cover, by sliding it back on.

NOTE:

- Do not combine new and worn-off batteries.
- Remove batteries when they are not in use for a long period of time.
- The remote control should be atleast 1Meter or more away from TV's or Audio devices.

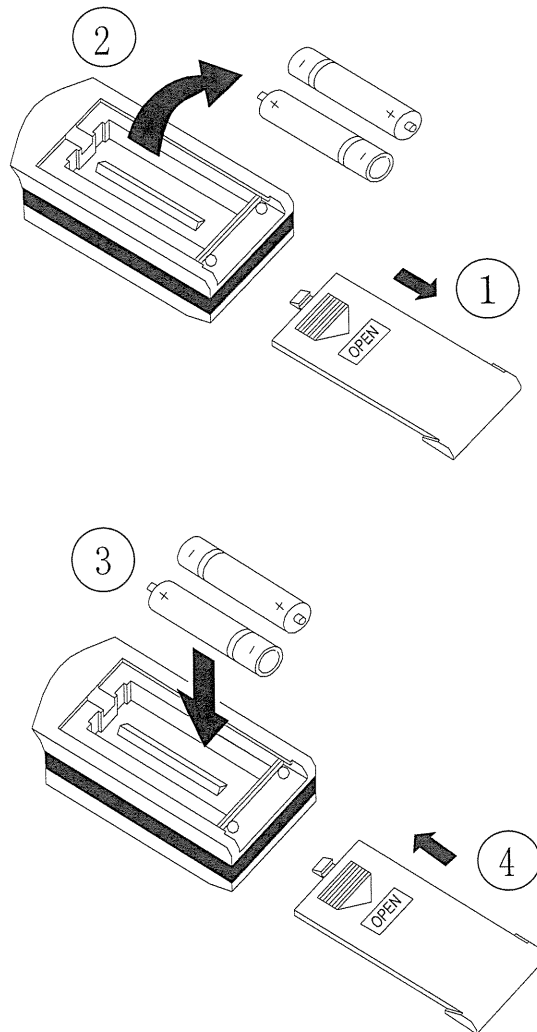

Emergency Operation Procedure

For use without the wireless remote control, open the surface panel and operate as per following:

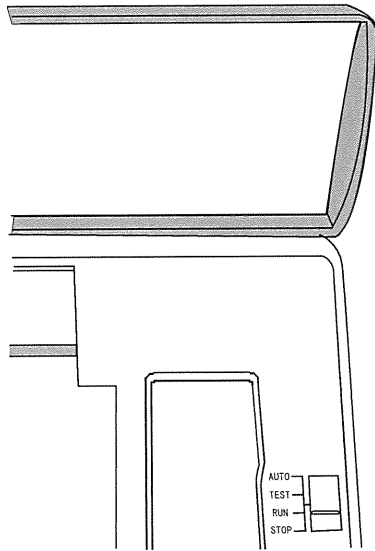

Manual Switch (Auto, Test, Run, Stop)

- a. If you turn the switch to Auto Position the unit will run in Auto Mode as per last set temperature.
- b. If turned in to Test Position, the main unit will enter into Cool Mode. The indoor fan will run at high fan speed and if a remote control signal is detected, the main unit will run according to this signal. It will also shield the low pressure switch.
- c. If turned in to Run Position, the main unit will run according to the last setting that was on the remote.
- d. If switched to the Stop Position, the unit will stop running.

Air Flow Direction Adjustment Procedure

1. Adjusting **up/down** air flow direction

Using the wireless remote controller, adjust the air flow direction by rotating the UP/DOWN deflectors to suit the angle you wish to direct the air automatically. To do this:

- * Press the SWING button, the deflectors will start to rotate. Once it reaches the desired direction, press SWING again to stop.

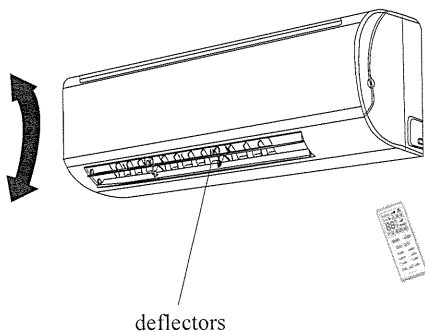

2. Adjusting **left/right** air flow direction

As shown below, move the LEFT/RIGHT deflectors by hand to adjust the air flow direction left or right. Or you can point it in three different directions to suit every corner of your room for even temperature distribution.

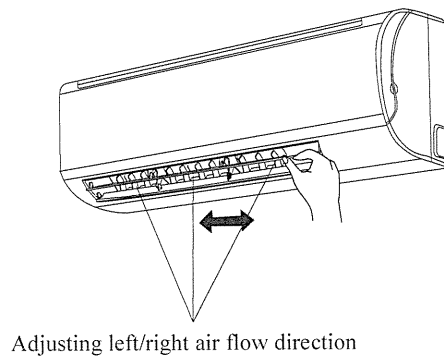

Special Features

Time delay in heating	When power fails
<p>* To avoid cold air, the indoor fan motor will not start till the compressor works according to the indoor tube thermostat.</p> <p>* To continue heating when room temperature reaches SET temperature, the compressor stops. However, the indoor fan motor will operate at the set speed for one minute before it shuts off.</p>	<p>* All operations stop.</p> <p>* Press ON/OFF button to restore operations.</p> <p>* If you have made mistakes while setting up operation, switch off unit, turn power back on and then press ON/OFF button to reset.</p>

Operating Conditions

Operating COOL Mode	Avoiding evaporator frost
<p>Outdoor temperature should be in the range of 18°C - 43°C if not it is possible for the Air Conditioner to malfunction.</p> <p>Room temperature should be in the range of 16°C - 32°C</p> <p>Room humidity should be lower than 80%, or else it is possible for dew to collect on the Air Conditioner's surface and even drip water.</p>	<p>Once the compressor has been continually working for more than 6 minutes and the evaporator pipe temp is kept no higher than 0 °C for 3 minutes, the compressor and outdoor fan motor will stop. The indoor fan motor will still run at SET SPEED. When the evaporator pipe temperature is no longer lower than 10°C, with approximately 3 minutes delay, the Air Conditioner will resume to its normal operation.</p>
Operating DRY Mode	Operating HEAT Mode
<p>Outdoor temperature should be in the range of 18°C - 43°C if not it is possible for the Air Conditioner to malfunction.</p> <p>Room temperature should be in the range of 16°C - 32°C.</p>	<p>Outdoor temperature should be over -7°C, or it is possible for the electric safety protection to activate and the Air Conditioner will not start till normal operating temperature is reached.</p>

Installation Precautions

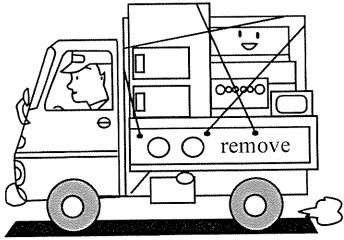
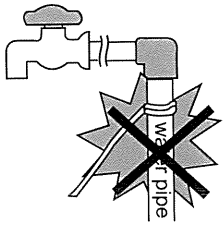
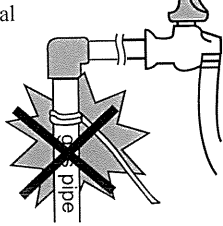
Installation position	Noise
<ul style="list-style-type: none"> * Drain the condensed water from indoor unit into a ground pipe. * Install indoor unit away from any TV's or radios etc. to avoid disturbing any audio output. * In coastal areas or places near thermal springs or polluted by sulphureous gas, contact your retailer before use. * Avoid installation where the unit can come to contact with flammable gas. * Avoid other heat sources or direct sun light. * Avoid positioning the unit where it will be easily accessible to children. 	<ul style="list-style-type: none"> * Affix unit firmly enough to avoid transmitting or increasing noise and vibration. * Do not put objects in front of the outdoor unit air outlet. * Please contact your retailer as soon as you notice any strange/continuous noise during operation.
Removing an installed unit	Electric lines
<ul style="list-style-type: none"> * Please contact your registered service technician before removing or shifting an installed unit. 	<ul style="list-style-type: none"> * Must be earthed. * Must use rated voltage and electric circuit specific for each Air Conditioner. * Do not pull power lines with force. * To fit an electrical leakage-proof switch, please contact your installer. * Choose a proper fuse to match the rated electricity specification.
Earth wire Do not connect earth wire to any of the following places:	
<p>Water Pipe</p> <p>Some plastic materials such as polythene is used as a part of water pipes and it is not safe to connect an earth wire to this.</p> 	<p>Gas Pipe</p> <p>If there was an accidental electrical leakage from the Air Conditioner, it can easily cause a fire. Therefore it is not safe to connect earth wiring.</p> 

◆ Clean and care



Caution

- Before cleaning, turn the power off and unplug the unit to prevent electric shock. To clean, use a damp cloth to wipe the unit down.
- Never put water on or in the unit when cleaning, or electric shock may occur.
- Never use flammable liquids to clean the air conditioner.

To clean the front panel

To clean the front panel, use a cool or lukewarm damp cloth and wipe the panel down. Never immerse the front panel in water, as this will damage the microcomputer and its circuits.

Clean the air filter every three months. If there is a lot of dust in or around the air conditioner, clean the air filter every month.

Please note: Once the filter has been removed, do not touch the fin inside the unit.

① To remove the air filter

Pull up gently on the front cover. The cover will hinge upward (figure a). Pull the air filter down and out of the unit (figure b).

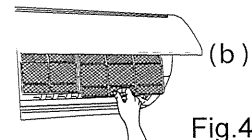
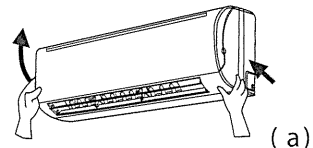
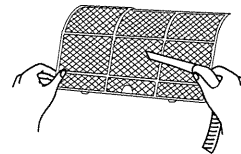

Fig.4

② To clean the air filter

To clean the air filter, you can either use a vacuum cleaner OR wash the filter with warm water and a gentle detergent. Allow the filter to dry in a sheltered location.

Please note: Never clean the filter with water above 45°C, or the unit may become discolored or deformed. Never dry the filter by a fire.



③ To re-insert the air filter

Slide the air filter back into the unit. Lower the front cover back into position and push gently to close.

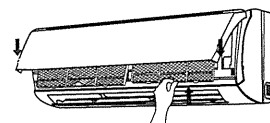

◆ Clean and care

Check before use

- ① Make sure nothing is obstructing the intake or outlet vents.
- ② Make sure the ground wire is properly connected.
- ③ Check the batteries.
- ④ Make sure the outdoor stand is not damaged. If it is, please contact the retailer for further assistance.

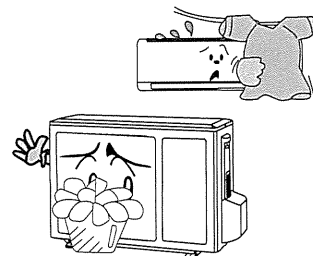

Maintenance and Upkeep



- ① Turn main power off.
- ② Clean the filter and wipe down the outside surfaces.
- ③ Clear dust and obstructions from the outdoor unit.

◆ Troubleshooting

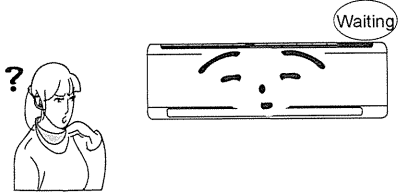
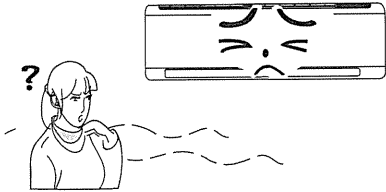
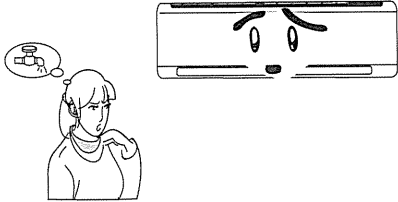

CAUTION

Do not attempt to repair the unit by yourself. If the unit is not functioning properly, please check the following troubleshooting guide before contacting Dimplex customer services.

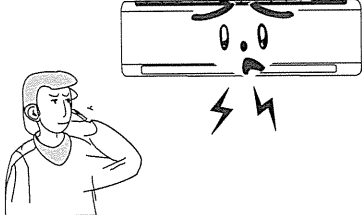
Malfunction	Solution
<p>The unit does not restart.</p> 	<p>☒ Once the air conditioner has been turned off, it will not restart within three minutes. This is to prevent system overload.</p>
<p>There is a bad smell coming from the unit.</p> 	<p>☒ Clean the air filter. If the smell persists, please contact Dimplex customer services.</p>
<p>Gurgling or dripping sounds are heard from the unit.</p> 	<p>☒ This is due to refrigerant flowing inside the unit. This is normal.</p>
<p>In COOL mode, a mist is produced through the vent.</p> 	<p>☒ This can happen with high air temperature and humidity levels. After the unit has been running for a while, the mist will disappear.</p>
<p>Creaking noises are heard from the unit when it is turned on or off.</p> 	<p>☒ This is caused when changes in temperature warp the plastic. It is normal as long as its not continuous.</p>

◆ Troubleshooting

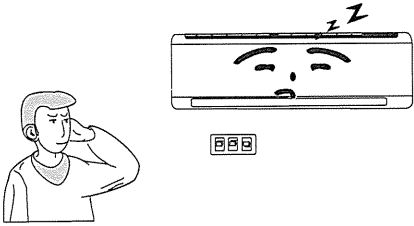
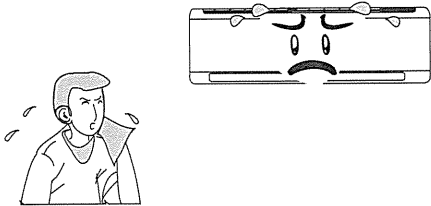
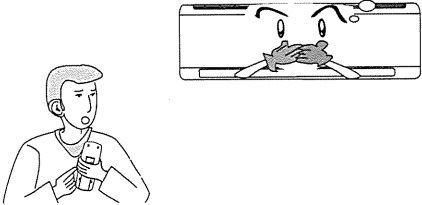
Malfunction	Solution
<p>The unit is not running.</p> 	<ul style="list-style-type: none"> ● Is the power turned off? ● Has the cable come out of the outlet? ● Has the circuit breaker tripped? ● Is the voltage of the outlet too high or too low? (Please get a professional to test this.) ● Is the TIMER on?
<p>The unit is not cooling or heating efficiently.</p> 	<ul style="list-style-type: none"> ● Is the set temperature suitable? ● Are the intake and outlet vents blocked? ● Is the filter dirty? ● Are the windows and doors open? ● Is the fan set on LOW speed? ● Are there any other heating or cooling sources in the room?
<p>The remote control is not working.</p> 	<ul style="list-style-type: none"> ● The unit can occasionally get overloaded from too many remote control commands. ● Is the remote control within range of the unit? Are there any obstructions? Are the batteries flat? ● The remote control may be damaged. Please check if the remote functions are operating as per normal.
<p>Water is leaking out of the indoor unit.</p>	<ul style="list-style-type: none"> ● The air humidity is very high and water condensation is dripping out. Turn unit off until humidity levels decrease. ● The connection between the drainage pipe and the unit is loose.
<p>Water is leaking from the outdoor unit.</p>	<ul style="list-style-type: none"> ● When the unit is running in COOL mode, water may condense on the pipe and pipe connection. ● When the unit is running in DEFROST mode, ice may have thawed and water is draining out. ● When the unit is running in HEAT mode, condensation is dripping from the heat exchanger.
<p>Noise being emitted from the indoor unit.</p>	<ul style="list-style-type: none"> ● The fan or the compressor relays are running. It is normal. ● When the DEFROST mode has just started or stopped, refrigerant is flowing.

◆ Troubleshooting

Malfunction	Solution
Indoor unit is not blowing out any air.	<ul style="list-style-type: none"> ● If the unit is running in HEAT mode and the temperature of the heat exchanger is very low, it will stop before cold air comes out. ● When the unit is running in HEAT mode and the outdoor temperature is low or the humidity is very high, frost may form on the outdoor heat exchanger. If this happens, the unit will automatically defrost. During the defrosting, air will stop blowing, and water or vapour may come out of the unit. ● If the unit is running in DEHUMIDIFY mode, the indoor fan may stop in order to prevent condensation from evaporating back into the air.
There is moisture on the air outlet vent.	<ul style="list-style-type: none"> ● If the unit is running in high humidity for long periods of time, moisture may condense and drip off the grill.



If any of the following situations occur, turn off and unplug the unit immediately and contact Dimplex customer services on 09 274 8265 (NZ) or 1300 556 816 (AUS)

- There is a loud or harsh sound coming from the unit.
- Water is leaking excessively from the indoor unit.
- The air switch or protection switch is broken.
- Water is spilled into the unit.
- The power cable and plug are abnormally hot.

Turn the unit off immediately.

◆ Installation Instructions



Important Notices

1. The unit must be installed by a qualified technician. Local laws and the instructions in this manual must be observed.
2. If the unit is not installed by an accredited installer, the unit may not be installed properly and malfunctions may occur. The Dimplex 5 year warranty will also be void.

Basic Requirements for Unit Location

This unit should not be installed in any of the following locations:

- Close to high heat sources or flammable vapours, gases, or materials.
- Close to high-frequency wave emissions, e.g. radio equipment, welding machinery, or medical equipment.
- Close to saltwater.
- Close to machine oil or vapours.
- Close to hot springs or sulfur vents.
- Other high-risk areas.

Choosing a Location for Your Indoor Unit

1. The air intake and outlet vents should not be blocked. Make sure air can circulate freely around the room.
2. Select a location where the condensed water can be easily drained. It should also be easily connectable to the outdoor unit.
3. The unit should be out of reach of children and pets.
4. The location must be strong enough to withstand the weight and vibration of the unit.
5. Make sure the unit is easily accessible for routine maintenance. The unit should be more than 2 meters off the floor.
6. The unit should be more than one metre away from televisions or other electric appliances.
7. Make sure the air filter is easily accessible.
8. The indoor unit location must comply with the installation dimension diagram requirements.
9. Do not install the unit close to a washing machine, clothes dryer, bath, shower, or swimming pool.

Choosing a Location for Your Outdoor Unit

1. Make sure the noise and air vents will not interfere with neighbours, animals, or plants.
2. Select a location where there will be sufficient ventilation.
3. Make sure the intake and outlet vents will not be blocked or obstructed in any way.
4. The location must be able to withstand the full weight and vibration of the unit.
5. Make sure the unit will be dry, but not directly in the sun or strong wind.
6. The outdoor unit location must comply with the installation dimension diagram requirements. It must also be easily accessible for maintenance and repair.
7. The Maximum height difference of connecting the piping with the indoor unit is 5m, the maximum length of connecting the piping should be 10m.
8. Select a location that is out of reach of children.
9. The unit should not be installed in such a way that will block walkways or footpaths, or in a location that will alter public spaces.

◆ Installation Instructions

Safety Requirements For Electric Appliances

1. The circuit and power supply must be compatible with the unit and cable.
2. Do not yank or tug on the power cable.
3. This unit must be properly grounded, and should therefore be installed by a qualified technician.
4. The unit should be installed at least 1.5 metres away from any flammable surface.
5. The unit must be installed in compliance with national and local wiring regulations.
6. An all-pole disconnection switch having a contact separation of at least 3mm in all poles should be connected in fixed wiring.

Note:

- ⊗ Faulty or incorrect connection may cause a fire.

Grounding Requirements

1. This unit is a type I appliance, and therefore must be properly grounded.
2. The green and yellow wire in this unit is the grounding wire. It may not be used for any other purpose. Tampering with this wire in any way may cause electric shock.
3. The grounding must comply with Australasian regulations.
4. The unit must be grounded properly. Do not connect the grounding wire to any of the following:
 - ① Water pipes
 - ② Gas pipes
 - ③ Sewage pipes
 - ④ Other places deemed unacceptable by a qualified technician
5. The model and rating values for fuses are listed on the energy label sticker on fuse cover or on the back of the PCB.

● Installation Dimensions Diagram

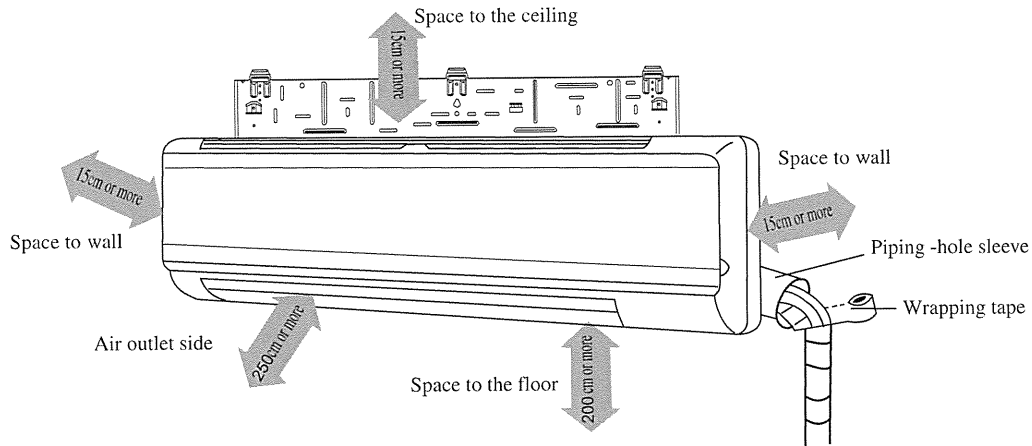

IMPORTANT NOTES

- * Installation must be done by a trained and qualified technician according to this manual.
- * DIMPLEX will not be responsible for incorrect installation of the unit. They are not covered under the warranty.
- * When picking up and moving the units, make sure you follow instructions as guided in this manual.
- * There should atleast be a 50cm minimum distance between the air outlet and any combustibile material in the room when using the Heating Mode.
- * This appliance should be installed in accordance with NZ/AUS wiring regulations.

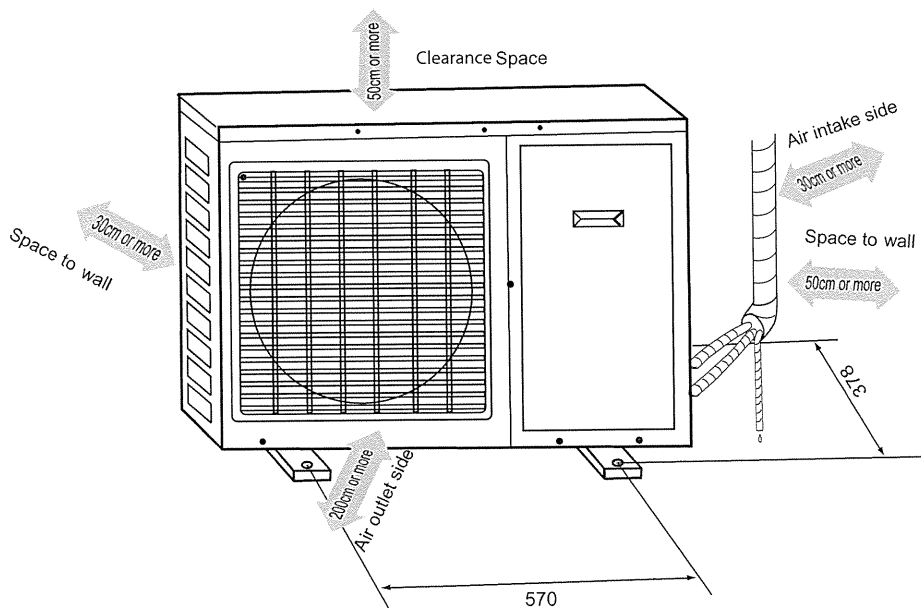

Installing the Indoor Unit

● Installing the rear panel

1. Always mount the rear panel horizontally.
2. Fix the rear panel on the selected location with the supplied screws.
3. Make sure that the rear panel has been fixed firmly enough to withstand the weight of an adult of 60kg. The weight should be evenly shared by each screw.

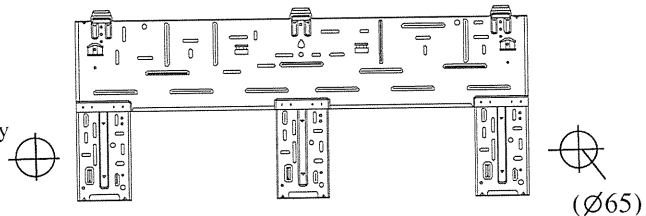

(Fig.2)

● Installing the drain hose

1. For optimum draining, the drain hose should be placed on a downward angle.
2. Do not wrench or bend the drain hose.

● Installing the piping hole

1. Make the piping hole ($\varnothing 65\text{mm}$) in the wall at a slightly downward angle to the outdoor side. The center of the hole should be determined as per Fig.2.
2. Insert the piping-hole sleeve into the hole to prevent the connection piping and wiring from being damaged when passing through the hole.

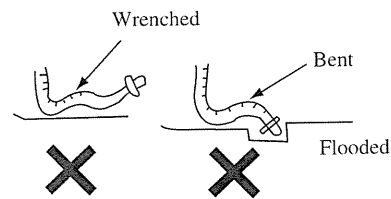

(Fig.3)

● Installing the connection pipes

Connect the connection pipes with the relevant union pipes of the indoor unit (Shown on P18 “Installing the connection pipes”).

NOTE:

- Connect the connection pipes with the indoor unit first and then to the outdoor unit.
- Be careful when bending the connection pipes, or you may cause damage.
- If the tightening torque is too great when tightening the flare nuts, it is possible for it to leak.

● Electrical wiring

1. Open the surface panel.
2. Remove the wiring cover. (Fig.4)
3. Route the power connection cord from the back of the indoor unit and pull it towards the front through the wiring hole for connection.
4. Connect the blue wire of the power connection cord to the terminal “N(1)”, the black one to “2”, the brown one to “3”, and the yellow-green one (earth wire) to “⊕” as shown in Fig.4.

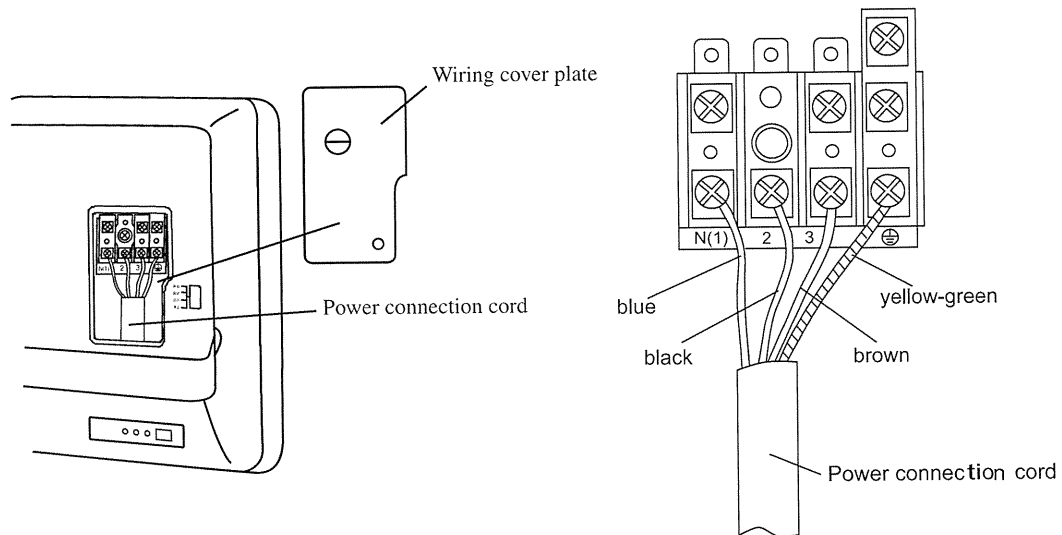

(Fig.4)

NOTE:

- All the electrical work must be done by a qualified technician according to NZ/AUS wiring regulation as well as instructed in this manual.
- The power supply is a type Y connection. If the supply cord is damaged, it must be replaced by the manufacturer or its service agent or a similarly qualified person in order to avoid a hazard.
- The rated voltage and the exclusive circuit must be used.
- A leakage circuit-breaker and air switch of correct capacity must be installed. The air switch of 32A should be used in these models.

● Installing the indoor unit

1. When routing the piping and wiring from the left or right side of the indoor unit, cut off the tailings from the chassis if necessary (shown in Fig.5).
 - ① Cut off tailing 1 when only power cord is routed.
 - ② Cut off tailings 1 and 2 when connection pipe and power cord are routed.
2. Wrap the piping and wiring and pull them through the cut-off tailings hole (shown in Fig. 6).
3. Hang the 2 mounting slots of the indoor unit on the upper tabs of the rear panel and check if they are secure.
4. The height of the installed location should be 2.3 Meters or more from the floor.

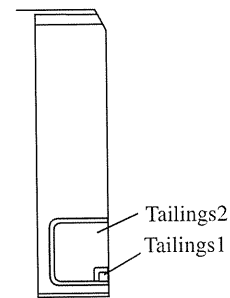

Fig.5

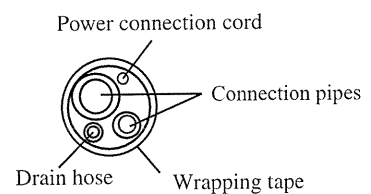

Fig.6

Installing the Outdoor Unit

● Installing the connection pipes

1. Align the center of the piping flare with the relevant valve.
2. Screw in the flare nut by hand and then tighten the nut with a spanner and torque wrench. (refer to the diagram on the right)

Note: Exceeding the tightening torque will damage the flare surface.

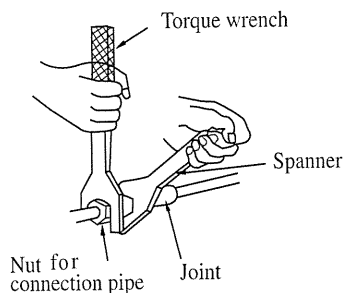

Fig.7

Tightening torque table

Hex nut diameter (mm)	Tightening torque(N·m)
∅ 6	15~20
∅9.52	31~35
∅12	50~55
∅16	60~65

● Electric wiring connection

1. Remove the front side plate (Fig.8).
2. Break through the hole for wires and put on rubber bush.
3. Pull all wires throught the rubber bush.
4. Remove the wire clamp and connect the end of the power connection cord with screws to the wiring terminal board according to the "WIRING DIAGRAM" of the outdoor unit.
5. Make sure that the wiring has been connected firmly.
6. Tighten the wire with a clamp and clasp.

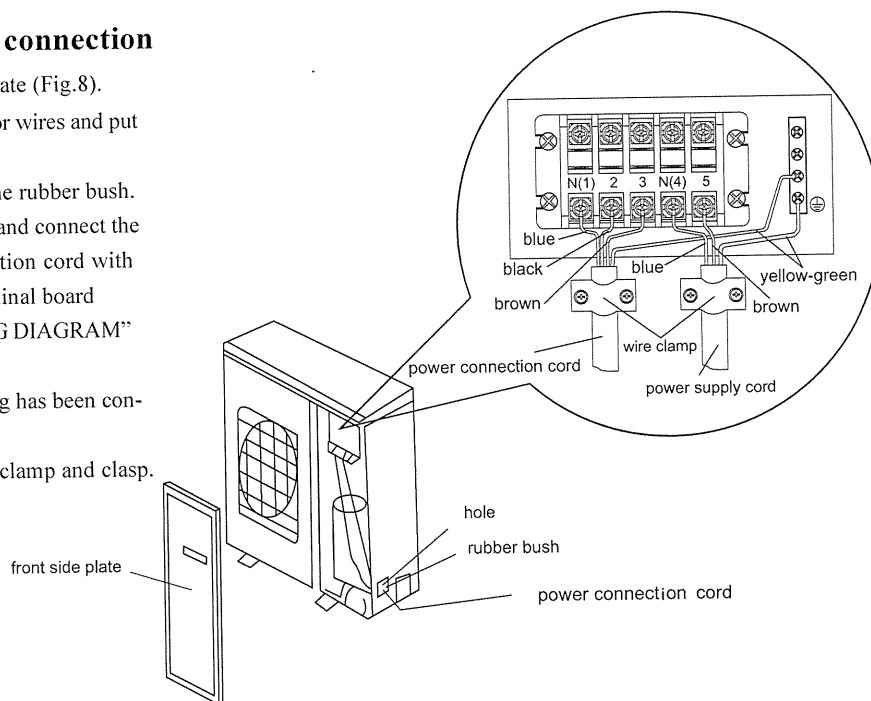
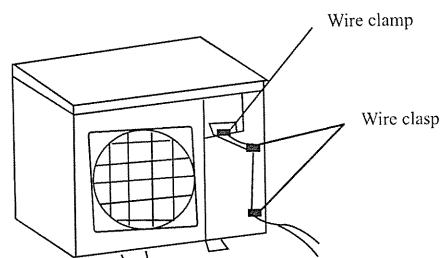

Fig.8

NOTE:

Incorrect wiring connections will cause electrical malfunctions.

**Do not pull the wire when fixing it to the wire clamp.
Do not leave the wire too loose in the outdoor unit.**



Installing the Outdoor Unit

● Connecting the pipe

1. Remove the flare nuts from the cut-off valves of the outdoor unit.
2. Align the center of the piping flare with the relevant valve, and screw in the flare nut about 3~4 turns by hand.
3. Tighten the flare nut with a spanner and torque wrench.
4. Remove the valve caps of the gas valve, liquid valve and the service port nut.

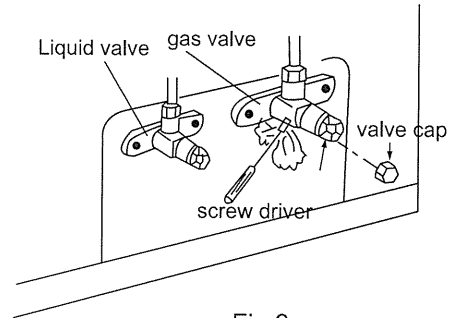

Fig.9

● Air purging and leakage test

For Air Conditioners with R410A refrigerant, use following steps:

1. Loosen the valve stem of the liquid valve with a hex wrench.
 2. Push the check valve core of the gas valve to discharge air and moisture remaining in the refrigerant system.
 3. Stop pushing the valve core as soon as the refrigerant starts to discharge and reinstall the service port nut.
 4. Open the liquid valve and gas valve entirely (shown in Fig.9).
 5. Tighten the valve caps and test leakage at all joints of the piping (both indoor and outdoor) with liquid soap or a leak detector.
 6. If possible, discharge air and moisture remaining in the refrigerant system with a vacuum pump. (shown in Fig.10)
 - I. Remove the nuts on the one-way valve.
 - II. Evacuate air from the one-way valve with a vacuum pump until the vacuum meter is 5 Torr, and keep up evacuating for 1 hour or more.
 - III. Turn off the valve and tighten the nuts.
 - IV. Fully open valves. (Fig.9)
 - V. Tighten the nuts, then check whether there is any gas leaking out.
- *Moisture inside pipeline must be less 200 Ppm.

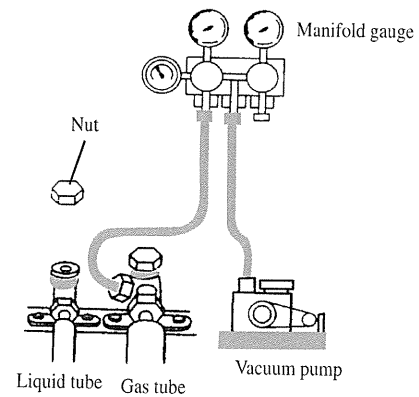

Fig.10

● Outdoor condensation drainage (Heat pump type only)

When the unit is heating or defrosting, the waste water formed in the outdoor unit can be drained out reliably through the drain hose.

Installation:

Install the outdoor drain elbow in the $\phi 25$ hole on the base plate as shown in Fig.11, and join the drain hose to the elbow, so that the waste water formed in the outdoor unit can be drained out to a proper place.

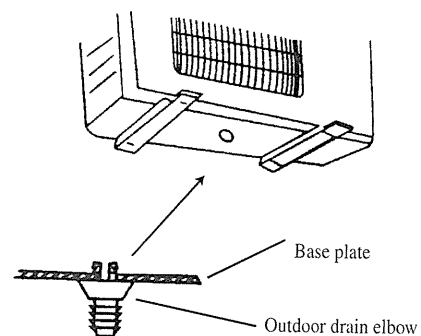

Fig.11

◆ Post-installation checklist and operation test

Check after installation

Things to check	If improperly installed...
Is the unit securely attached to the wall?	The unit may shake, make loud noises, or fall down.
Have you done the refrigerant leakage test?	The unit may not heat or cool efficiently.
Is the unit properly insulated?	Condensation may form.
Is the water draining properly?	The unit may leak.
Does the outlet match the voltage requirements of the unit?	The unit may malfunction.
Is all piping and wiring properly and securely installed?	The unit may malfunction.
Is the unit properly grounded?	It may leak electricity or cause electric shock or fire.
Is the proper power cable attached?	The unit may malfunction.
Are the intake or outlet vents blocked?	The unit may not heat or cool efficiently.
Has the length of connection pipes & refrigerant capacity is in accordance with specifications?	The unit might not work properly

Operation Test

1. Before testing operation

- (1) Do not turn the unit on before installation is complete.
- (2) Make sure all wiring is properly connected.
- (3) The cut-off valves of the connection pipes should be open.
- (4) Any scraps or rubbish must be removed from the unit.

2. To test the unit:

- (1) Turn on the main power. Use the ON/OFF button on the remote control
- (2) Press the MODE button. Test the COOL, HEAT, and FAN functions to make sure everything is working properly.

◆ Installation and Maintenance of Silver Ion Filter

Installation Instructions

1. Pull up gently on the front cover. The cover will hinge upward. Pull the air filter down and out of the unit (see Figure a).

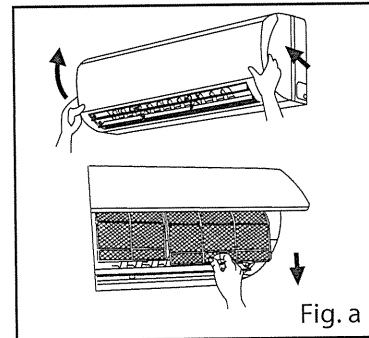

2. Mount the Silver Ion filter onto the air filter, (as shown in Figure b). If the air filter cannot be installed, mount the Silver Ion filter on to the front case. (as shown in Figure .c)

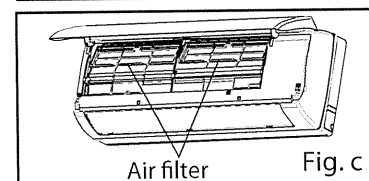
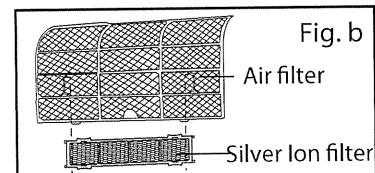

3. Slide the air filter back into the unit. Lower the front cover back into position and push gently to close (see Figure d).

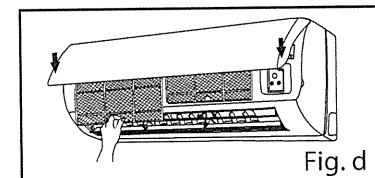

Cleaning and Maintenance

You can remove the air filter for cleaning purposes. You can use water or a damp cloth to clean the normal air filter. However, **Do Not** clean the Silver Ion filter in water. Only use a soft cloth or a brush to wipe off any dust or dirt. None of the filters should be scrubbed with abrasive materials.

Service Life

The Silver Ion filter is usable for approximately one year, if it is taken care of properly. The silver ion filter must be replaced once it turns black or green.

Contact Details:

Glen Dimplex Australia Pty Ltd
2/205 Abbots Road
Dandenong South 3175
Victoria, Australia
Phone: 1300 556 816
Fax: 1800 058 900
Email: sales@glendimplex.com.au
web: www.dimplex.com.au

Glen Dimplex New Zealand Ltd
P.O. Box 58473 Botany
Manukau 2163
New Zealand
Phone: 09 274 8265
Fax: 09 274 8472
Email: sales@glendimplex.co.nz
web: www.dimplex.co.nz